

Wiring diagram for security alarm sensors with NO - normally open contact types

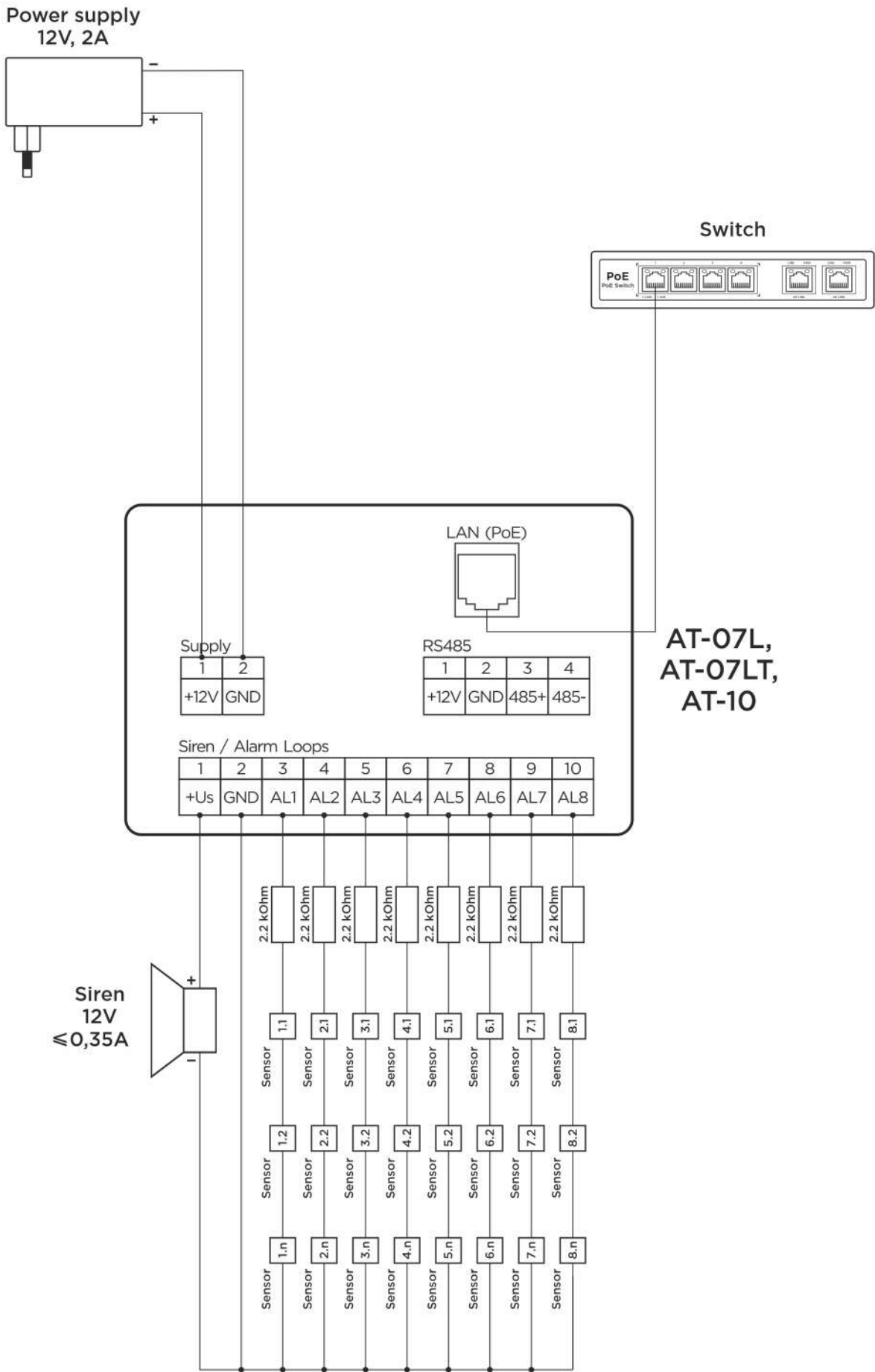

AT-07L,
AT-07LT,
AT-10

Wiring diagram for security alarm sensors with NC - normally closed contact types

Power supply
12V, 2A

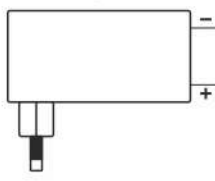

Switch

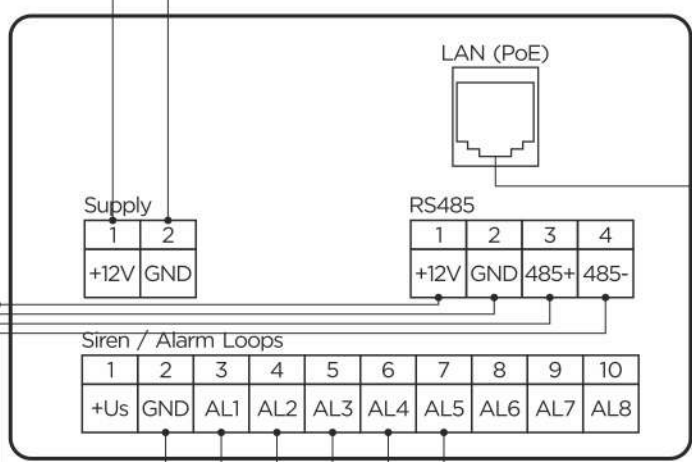
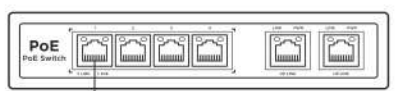

AT-07L,
AT-07LT,
AT-10

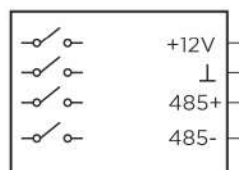

Expansion module
SH-16

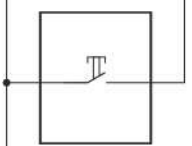

Bell button
normal

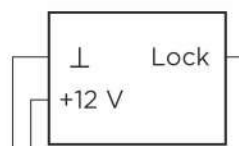

Universal button
SH-47T

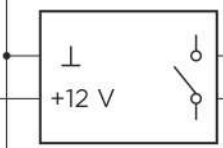

Button SH-45

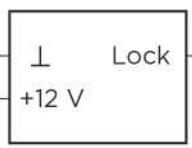

Button SH-45T

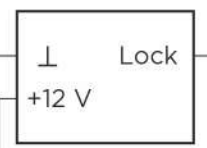

Bell button
SH-46T

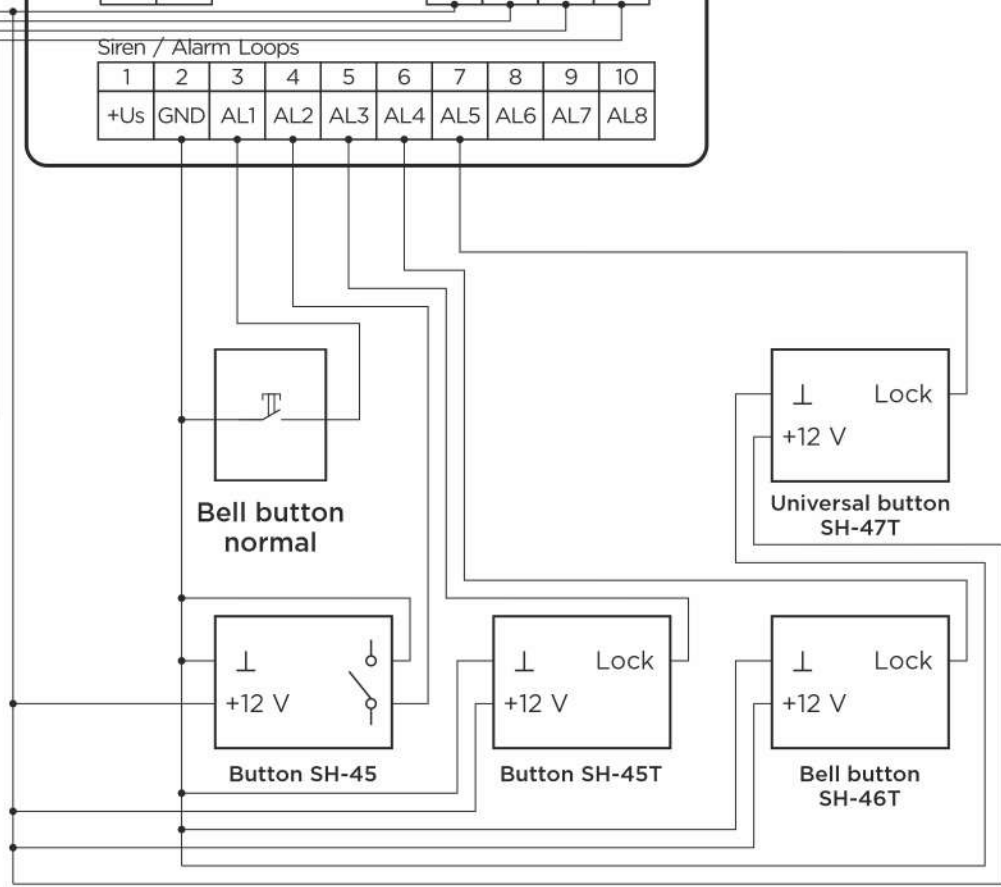

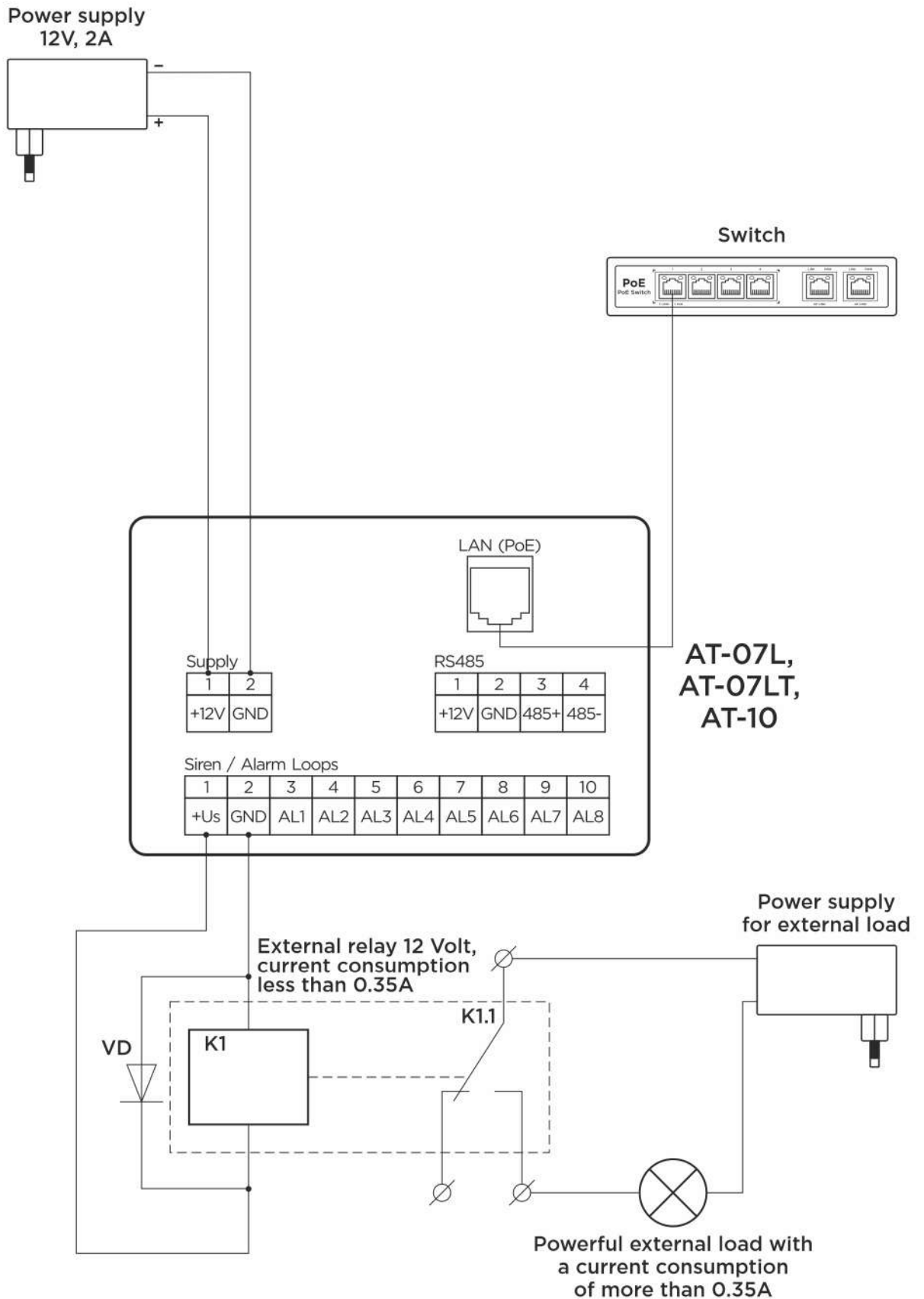

Scheme for connecting external controlled devices or connecting a powerful external load to the siren output using an external additional relay