

Using the siren output as a controlled output, to control devices or any other external load with high current consumption

Power supply
12V, 2A

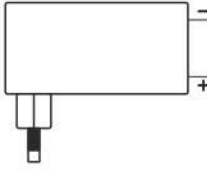

Switch

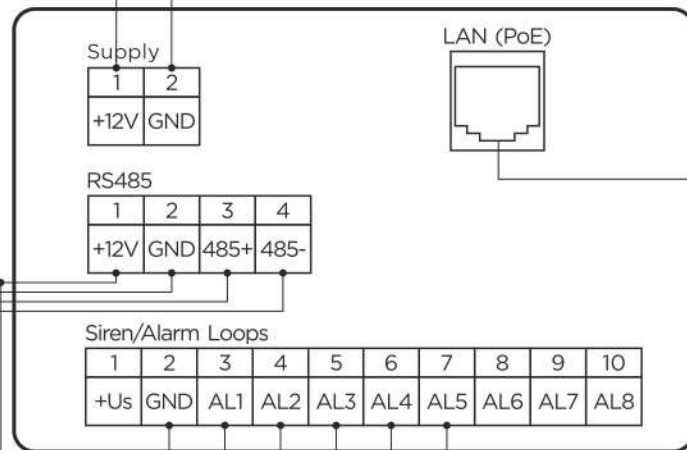

AQ-07, AQ-07L,
AQ-07LA,
AQ-07LL,
AK-10, AK-10L

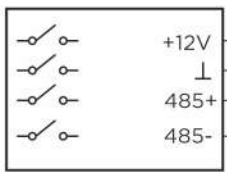

Expansion module
SH-16

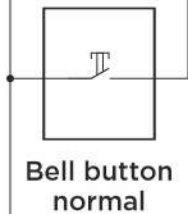

Bell button
normal

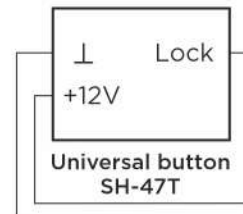

Universal button
SH-47T

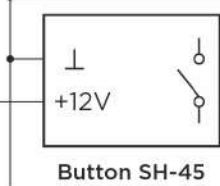

Button SH-45

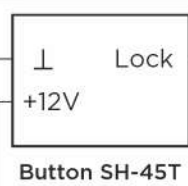

Button SH-45T

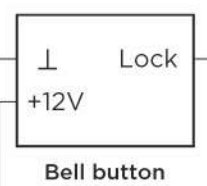

Bell button
SH-46T

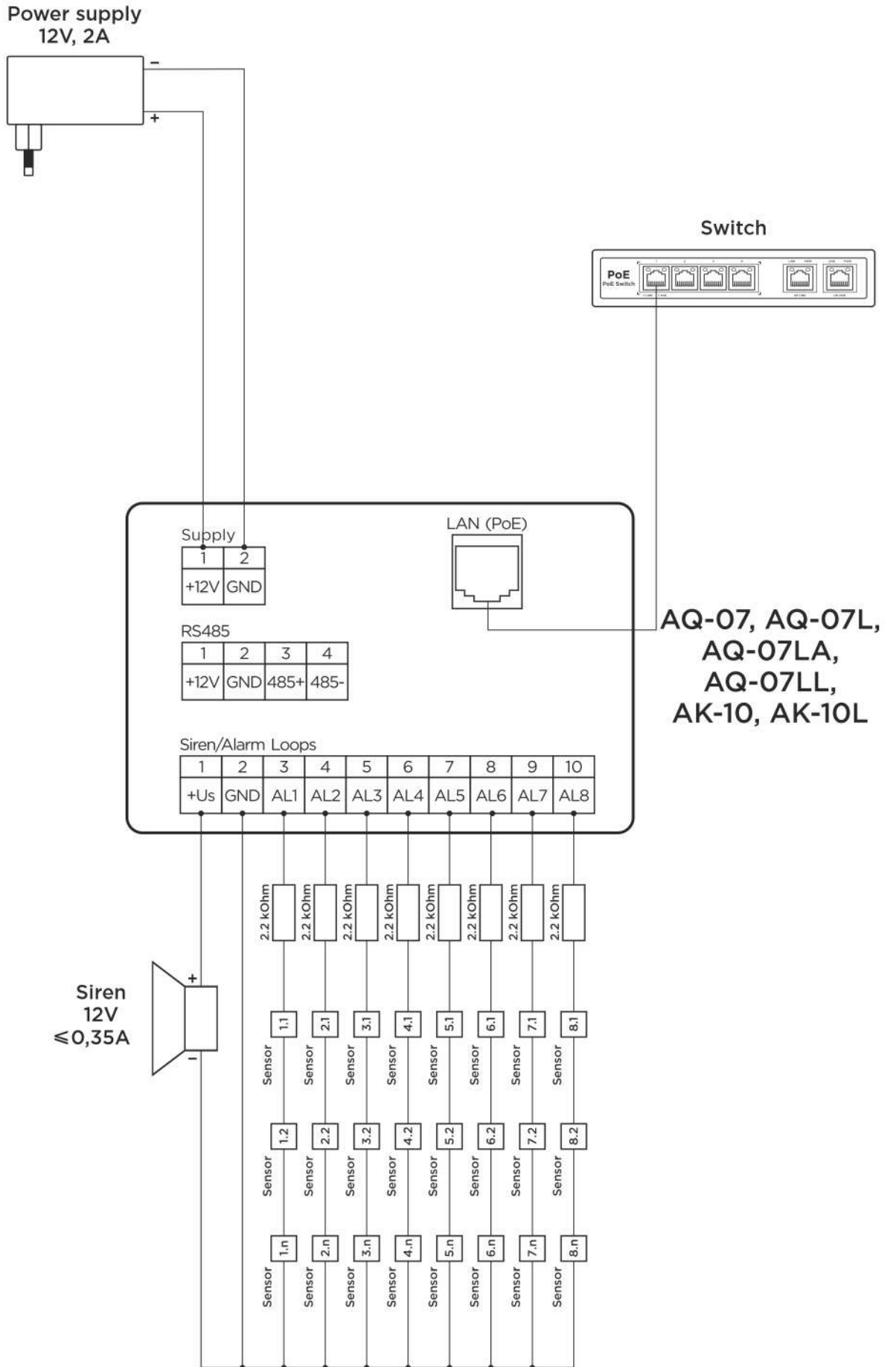

Wiring diagram for security alarm sensors with NC - normally closed contact types

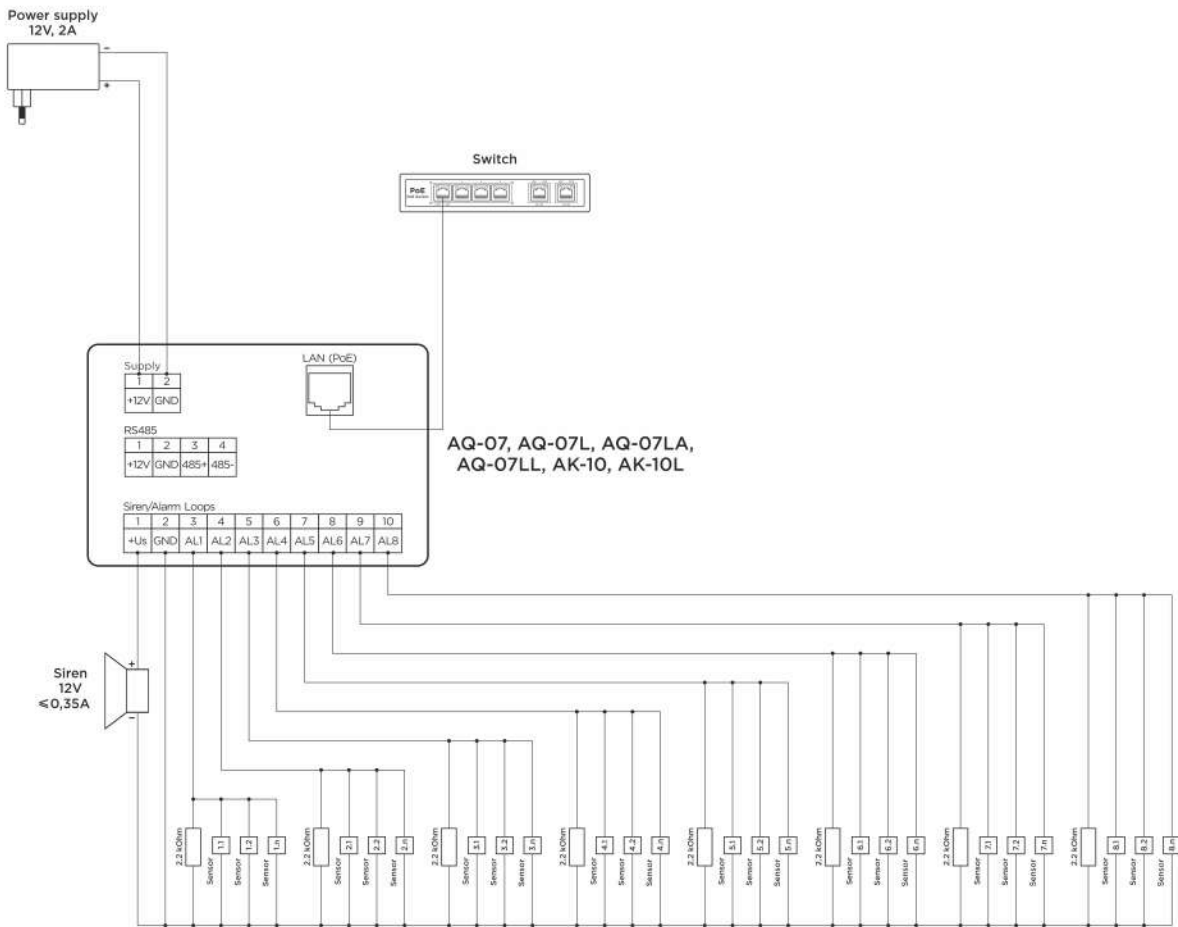

Wiring diagram for security alarm sensors with NO - normally open contact types