

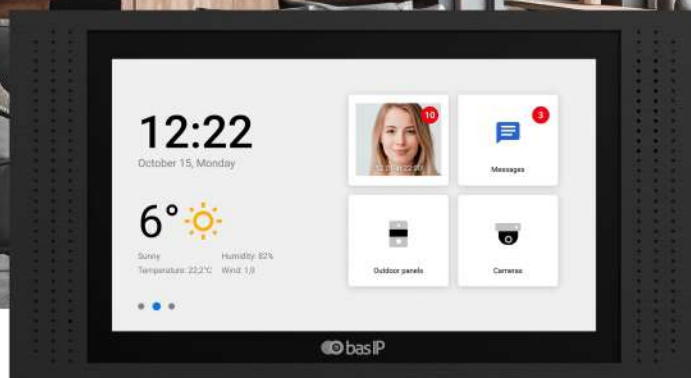

AT-07L

IP INDOOR VIDEO ENTRY PHONE



Description

7" IP indoor video entry phone with IPS screen, resolution 1024x600 and the ability to connect alarm sensors.

The indoor video entry phone works on the Android 10 operating system.

It comes in 2 color variations: White, Black and has two installation options: wall mount and flush mount, using a special bracket.













Specifications

Display	7" IPS LCD, capacitive touchscreen
Screen resolution	1024 x 600
Built-in camera	No
Power	PoE and + 12 V DC (PSU not included)
Power consumption	6 W, standby 2.5 W
Dimensions	236 x 128 x 26,5 mm
Colors	Black / White
Body	Aluminum
Installation Type	Wall mount, flush mount with special bracket.

Possibilities of connection

Number of individual panels	Up to 9 panels
Number of multi-apartment panels	Up to 9 panels
Connection of additional monitors	Up to 8 monitors
Additional connectors	SD card slot (SDHC)
Memory function	Record photo, video and audio to SD card
Interface	Multi-language graphical and WEB interface
Number of IP cameras	Up to 32 cameras

Main features

 7" IPS LCD touch screen	 Quad splitter
 Android OS	 Slot for SD card
 Lift call	 Ability to install third-party apps
 Concierge call	 Third-party widget support
 Downloading custom MP3 ringtones	 Software update via Ethernet
 High definition video support	 Wall and flush mounting installation

Functional capabilities

Number of call ringtones
 Download custom MP3 ringtones
 Intercom type
 Home automation control
 Scene
 Answering machine
 Support of receiving messages
 Multimedia features
 Standby mode

Select the type of screensaver
 in standby mode

Do Not Disturb
 Silent mode
 Backup photos taken during the call
 Ability to install third-party applications
 Support for third-party widgets

Software update

9 melodies to choose
 Yes
 Audio Intercom, no built-in camera
 Light / curtains / lift
 Yes
 Yes
 Yes
 View video, photo and audio files from an SD card
 Yes, customizable by time

Multi-camera live viewing — up to IP 4 cameras
 at the same time
 Clock
 Photo frame
 Live tour view — up to 16 cameras, time adjustable
 Single IP camera live viewing.

Yes, customizable by time
 Yes, customizable by time
 Yes, to the SD card
 Yes
 Yes

From the web interface
 From SD card
 From BAS-IP updates server

Color variations



BLACK



WHITE

Appearance and mechanical mounting

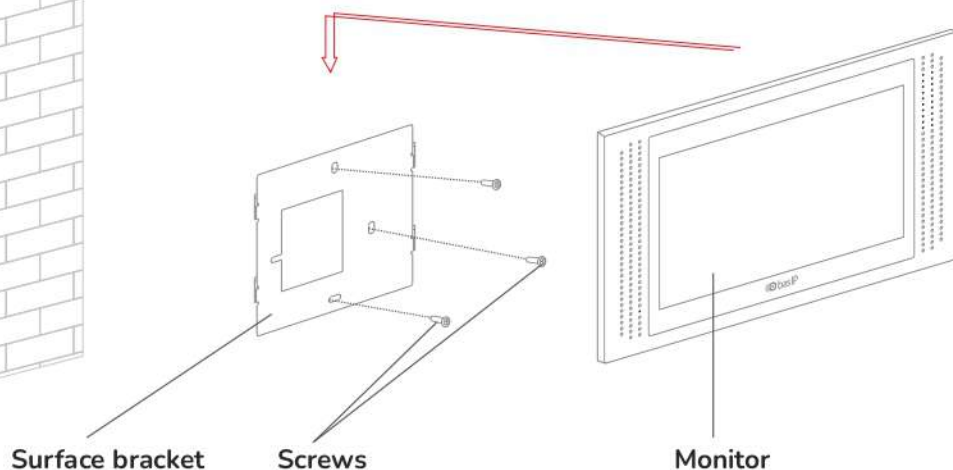
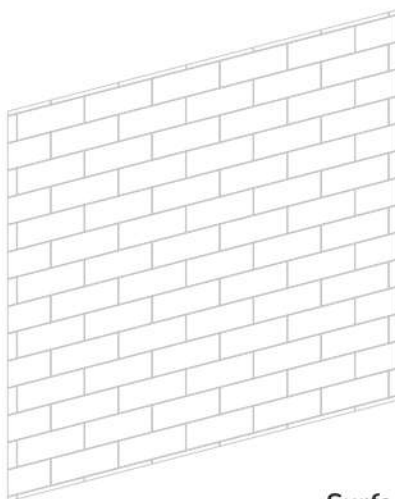
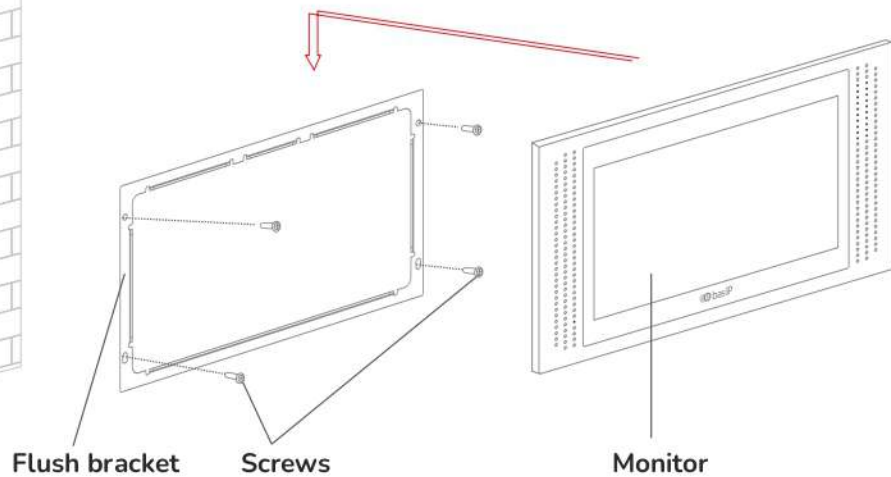
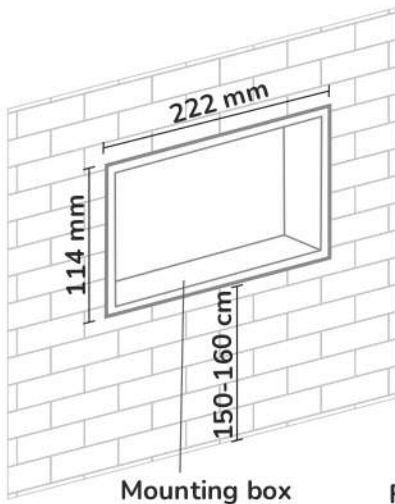

Flush mounting

Surface mounting